

Filament Books eBook Quick Start Guide

Filament Books

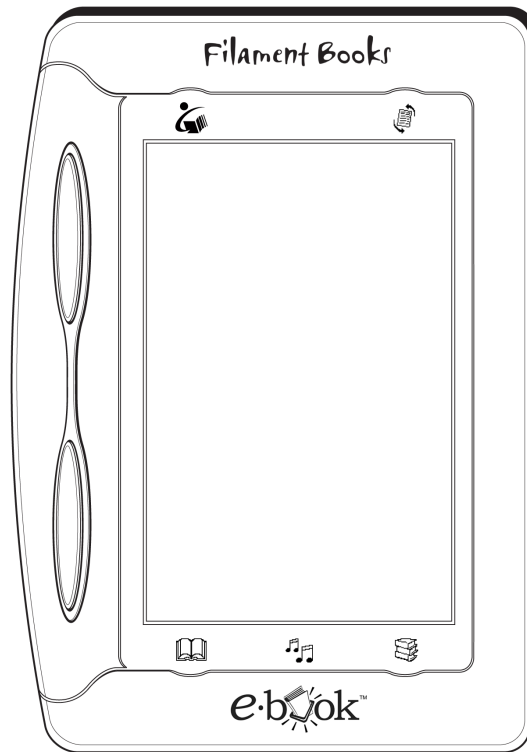

IMPORTANT

You must register your Filament Books reading device in order to get access to new eBook Editions.

Registering your eBook device sets up your personal eBook User ID and Online Bookshelf, allowing you to purchase and enjoy thousands of eBook Editions on your eBook device.

As an Filament Books eBook device owner you can get the eBook Editions you want more quickly and easily than you can from any other source of mobile electronic reading material.

This Quick Start Guide helps you connect and register your Filament Books eBook device and gives you an overview of its functions and features. More detailed instructions for using your eBook device are included in your eBook device on your eBookshelf under the title "eBook User's Guide."

The eBook logo is a trademark of eBook Technologies, Inc. or its related affiliates.
"Filament Books" and the logo Filament Books are trademarks of Filament Books, Inc.

Safety and Hardware

Important Safety Instructions - PLEASE SAVE

When using your Filament Books eBook device, you should always follow basic safety instructions to reduce the risk of fire, electric shock and injury to persons:

1. Do not use the eBook device near water; for example: near a bathtub, washbowl, kitchen sink or laundry tub, in a wet basement or near a swimming pool.
2. Avoid using the eBook device during an electrical storm. There may be a remote risk of electric shock from lightning.
3. Use only the power adapter included with your eBook device. Do not dispose of your eBook device in a fire. The internal rechargeable battery may explode. Check local codes for possible special disposal instructions.
4. CAUTION: To reduce the risk of fire, use only the enclosed No. 26 AWG or larger phoneline cord.
5. CAUTION: Do not remove the cover (or back). There are no user-serviceable parts inside. Refer servicing to qualified service personnel.
6. CAUTION: To ensure reliable operation and to prevent overheating, provide adequate ventilation for your eBook device and keep it away from heat sources. Do not locate it near heat registers or other heat-producing equipment. Provide for free air flow around the eBook device and its power supply.

Your Filament Books eBook Device Hardware

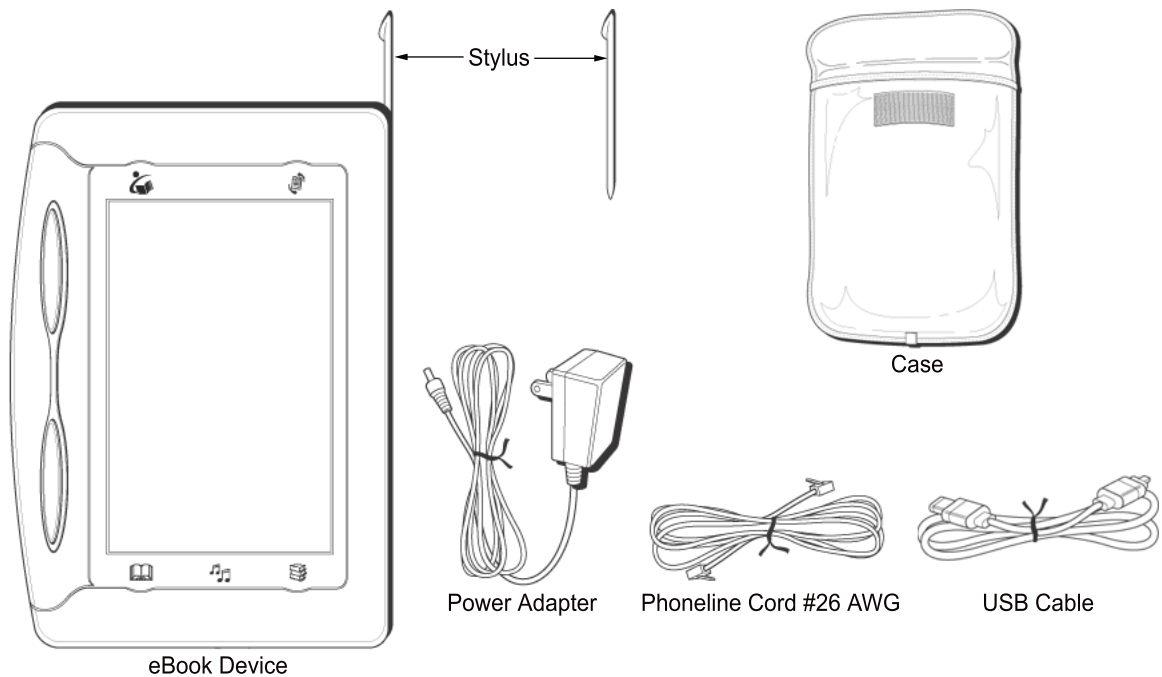

Features and Functions

Charge Your Filament Books eBook Device

Use the power adapter to fully charge your eBook device while using it for the first time. The battery is built in and cannot be removed. To charge your eBook device:

1. Locate the power adapter that came packed with your eBook device.
2. Open the tab on the top of your eBook device.
3. Plug the power adapter into an electrical outlet, then connect the other end to the adapter port on the top of your eBook device.

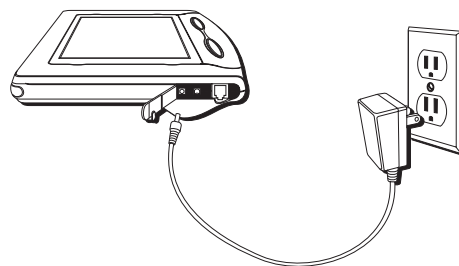

Keep your eBook device connected to the power adapter for up to two hours to fully charge the battery for the first time. When charging is complete, disconnect the power adapter. You can now use your eBook device anywhere.

Note: You can begin using your eBook device while it is charging, but it will take more than two hours to charge fully.

The Front and Side of Your Filament Books eBook Device

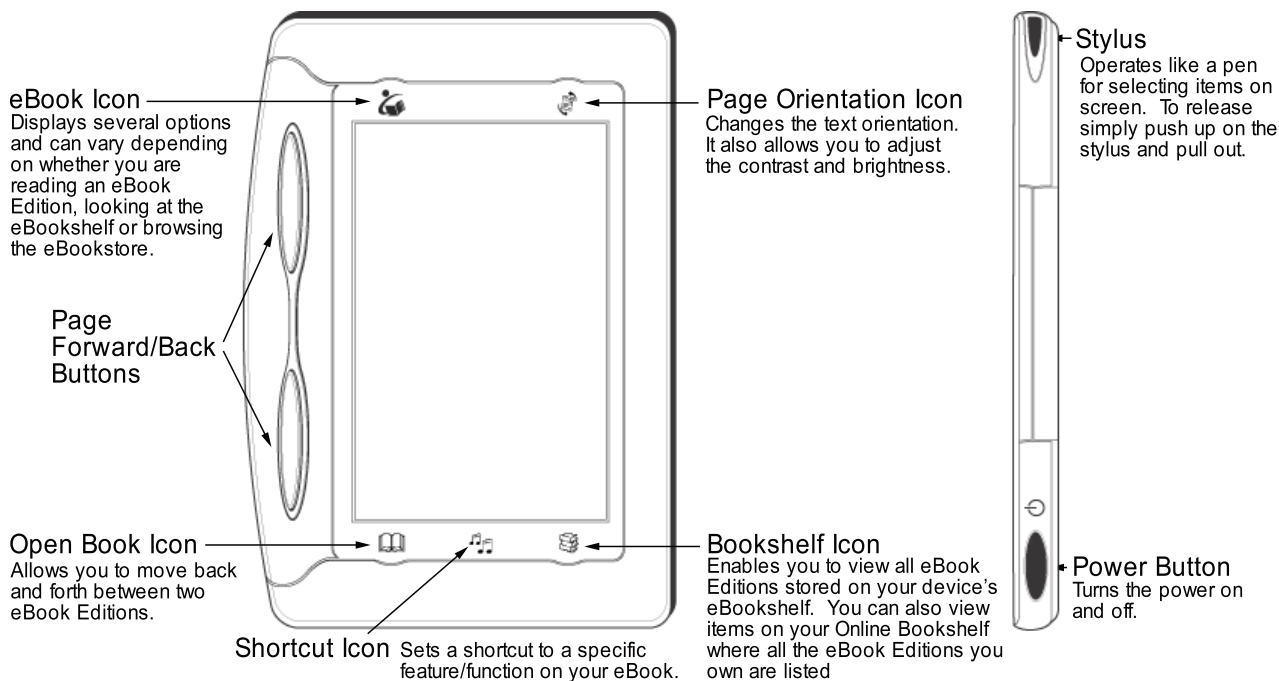

Adjusting Brightness and Contrast

Use the Page Orientation Icon to adjust the brightness and contrast of your eBook device to your personal needs.

Features and Functions

The Top of Your Filament Books eBook Device

The ports for the power, USB and phonline connections are located on the top of your eBook device. Open the rubber tab and fold it back to use these ports.

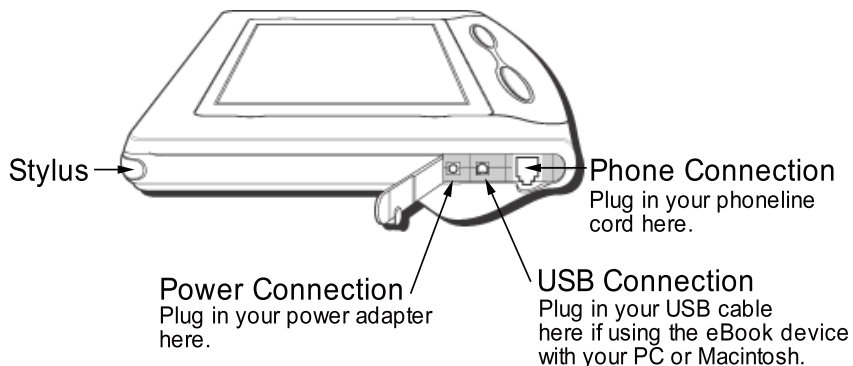

The Back of Your Filament Books eBook Device

Open the rubber tab on the back of your eBook device to find the reset button for your device and the SmartMedia™ Memory Card slot. The reset button allows you to reset your eBook device. The SmartMedia card (not included) is an optional accessory that allows you to add memory to your eBook device.

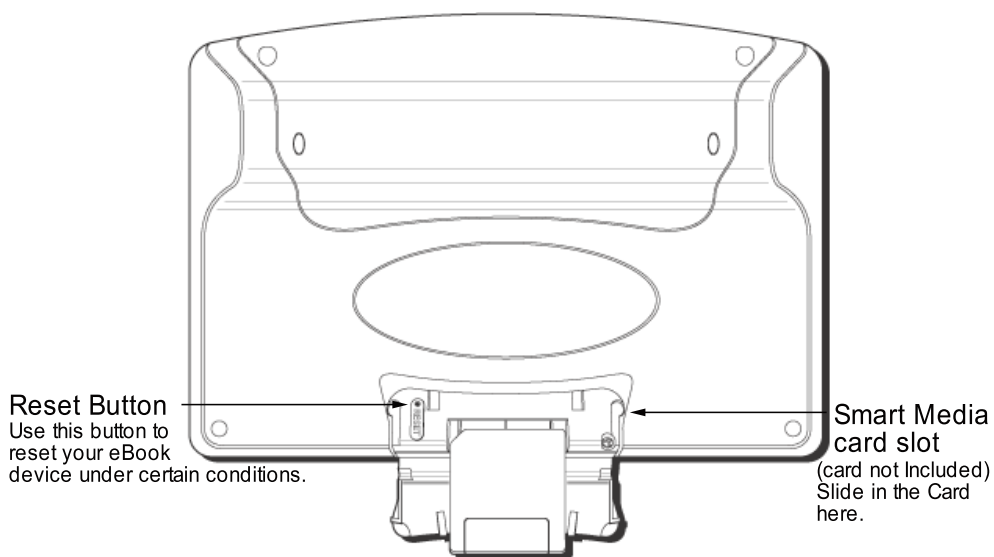

SmartMedia is a trademark of Legato Systems, Inc.

Registering Your eBook Device

Turn On Your Filament Books eBook Device

To turn on your eBook device:

1. Press the Power button once, which is located on the lower right side of your eBook device.
2. When the eBookshelf appears on the screen, proceed with connecting and registering your eBook device.

Connect Your Filament Books eBook Device to the eBook Network via Phonenumber or USB

Before using your eBook device and buying eBook Editions, you must register it by connecting to the eBook Network through a phonenumber or USB.

Using the Phonenumber Connection:

Open the tab on the top of your eBook device and connect one end of the phonenumber cord to your eBook device and the other end to a convenient analog phone jack.

Note: When you connect your eBook device to a phonenumber, make sure it is a normal analog line, not a digital line. Your eBook device cannot communicate through a digital phonenumber and runs the risk of damage. Home phonenumber lines are usually analog, but some or all lines in an office building, hotel, or similar location may be digital. The receptionist or office manager in most locations can tell you what type of line you are using.

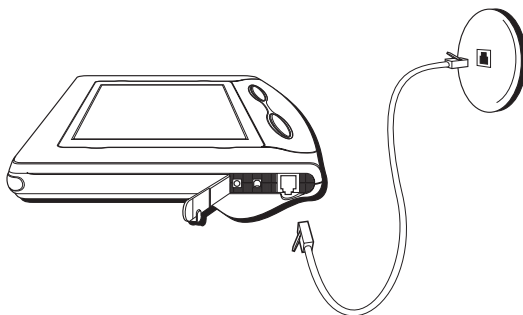

When you use the phonenumber, your eBook device dials a *toll* number to enable the registration process. If you are registering your eBook device from a location other than your home (for example, at work or a hotel), you may need to change the dialing prefix. To do this:

- Press the Power button to turn on your eBook device.
- Press the eBook icon on the upper left of the screen.
- Tap "Settings" on the Menu.
- Tap "Phone Connection."
- Select your settings by tapping the appropriate items for the dialing configuration you need.

Using the USB connection:

For USB connections utilizing your PC's or Macintosh's high-speed Internet access, please go to www.filamentbooks.com/drivers for additional information. You must download and install the eBook USB Driver software in order to use the USB connection with your eBook device.

Registering Your eBook Device

Register Your Filament Books eBook Device

Registering your eBook device sets up your personal eBook User ID and Online Bookshelf, allowing you to purchase and enjoy thousands of eBook Editions on your eBook device. Follow these instructions to register:

1. Tap the eBook icon at the upper left of the screen.
2. Tap "Bookstore" on the Menu. Your eBook device connects you to the eBook Network.
3. A screen appears with three sections:
 - a) If you are a new user or would like to create a new Online Bookshelf, tap "Create New Bookshelf." Provide the information requested by tapping on the text boxes and using the onscreen keyboard.
 - b) If you already have an Online Bookshelf and wish to transfer all eBook Editions to your new eBook device, enter your existing eBook User ID and Password. Tap "Connect to Existing Bookshelf" and verify the information you provided when you registered previously. Edit any text boxes you want to change by tapping on the box and using the onscreen keyboard.
 - c) If you are an eBook user and have forgotten your password, use the third section of this screen to enter your eBook User ID and Email Address so your password can be emailed to you. Tap "Email Me My Password," and your password will be emailed to you. If you need assistance, please contact customer service at 1-888-95 EBOOK.

The screenshot shows a registration screen with the following sections:

- Registration** header with the **eBook** logo.
- Text: "If you are a new user, or would like to create a new Online Bookshelf, tap the 'create new bookshelf' button below."
- Button: **create new bookshelf**
- Text: "If you wish to permanently move an existing Online Bookshelf to this eBook, tap on the text boxes below to enter your existing eBook User ID and password."
- Form fields: **eBook User ID:** [text box] and **Password:** [text box]
- Button: **connect to existing bookshelf**
- Text: "If you do not remember your password, just enter your eBook User ID or email address below, and your password will be sent to the email address that we have on file for you. If you do not have an email address on file with us, please call Customer Support for assistance."
- Form fields: **eBook User ID:** [text box] and **Email Address:** [text box]
- Button: **email me my password**

When you finish the registration process you can then begin to browse and purchase eBook Editions on the Web at www.filamentbooks.com.

Limited Warranty and License Agreement

Return Policy

The return policy is subject to the respective retailer's policy.

Limited Warranty

What your warranty covers:

- Defects in materials or workmanship.

For how long after your purchase:

- 90 days - Unit exchange, which includes parts and labor.
- 91 days to 1 year - Unit exchange, which includes parts only; you pay the labor.

What we will do:

- During the initial 90 days:
 - Exchange your eBook device with a new or, at our option, refurbished unit.
- After the 90 days and within one year:
 - Exchange your eBook device with a new or, at our option, refurbished unit.
 - We will charge you a flat exchange cost to replace a defective unit. This charge covers labor cost for its repair.

How you get service:

- For activation, account, or billing issues associated with eBook Editions, please call 1-888-95 EBOOK.
- For all issues related to the use and operation of your eBook device, please call 1-888-95 EBOOK.
- For warranty or repair issues for your eBook device, call 1-888-95 EBOOK and have your unit's date of purchase and model/serial number ready. The model/serial number information is on the back of your eBook device.
- A representative will troubleshoot your problem over the phone.
- If the representative determines that you should receive a replacement eBook device, you will be provided with a Service Request (SR) number and a shipping address. No returns will be accepted without the SR number.
- If the representative determines that your eBook device is defective they will arrange for its repair or replacement.

Filament Books assumes no responsibility for warranty shipments from the customer if not shipped in the manner specified by Filament.

What your warranty does not cover:

- Acts of nature, such as but not limited to lightning damage.
- Adjustment of customer controls.
- Damage from misuse or neglect.
- A unit that has been modified or incorporated into other products or is used for institutional or other commercial purposes.
- Units purchased or serviced outside the U.S.A.
- Loss of eBook Editions.
- Installation.
- Shipping damage if the unit was not packed and shipped in the manner prescribed by Filament Books.
- Storage fees may be charged by the exchange point if you fail to pick up the replacement unit in a timely manner.

Limitation of Warranty:

· THE WARRANTY STATED ABOVE IS THE ONLY WARRANTY APPLICABLE TO THIS PRODUCT. ALL OTHER WARRANTIES, EXPRESS OR IMPLIED (INCLUDING ALL IMPLIED WARRANTIES OF MERCHANTABILITY OR FITNESS FOR A PARTICULAR PURPOSE), FOR THE PRODUCT ARE LIMITED IN DURATION TO THE LIMITED WARRANTY PERIOD SET FORTH ABOVE AND NO WARRANTIES, WHETHER EXPRESS OR IMPLIED, WILL APPLY AFTER SUCH PERIOD. NO VERBAL OR WRITTEN INFORMATION GIVEN BY FILAMENT BOOKS, ITS AGENTS OR EMPLOYEES SHALL CREATE A WARRANTY OR IN ANY WAY INCREASE THE SCOPE OF THIS WARRANTY.

· REPAIR OR REPLACEMENT AS PROVIDED UNDER THIS WARRANTY IS THE EXCLUSIVE REMEDY OF THE CONSUMER. FILAMENT BOOKS SHALL NOT BE LIABLE FOR INCIDENTAL OR CONSEQUENTIAL DAMAGES RESULTING FROM THE USE OF THIS PRODUCT OR ARISING OUT OF ANY BREACH OF ANY EXPRESS OR IMPLIED WARRANTY ON THIS PRODUCT. THIS DISCLAIMER OF WARRANTIES AND LIMITED WARRANTY ARE GOVERNED BY THE LAWS OF THE STATE OF CALIFORNIA. EXCEPT TO THE EXTENT PROHIBITED BY APPLICABLE LAW, ANY IMPLIED WARRANTY OF MERCHANTABILITY OR FITNESS FOR A PARTICULAR PURPOSE ON THIS PRODUCT IS LIMITED TO THE APPLICABLE WARRANTY PERIOD SET FORTH ABOVE.

How state law relates to warranty:

- Some states do not allow the exclusion nor limitation of incidental or consequential damages, or limitations on how long an implied warranty lasts, so the above limitations or exclusions may not apply to you.
- This warranty gives you specific legal rights, and you also may have other rights that vary from state to state.

Limited Warranty and License Agreement

If you purchased your product outside the United States:

- This warranty does not apply.

End-User License Agreement

Important -- read carefully: This End-User License Agreement ("Agreement") is a legal contract between you (the "User") and Filament Books and eBook Technologies, Inc. (the "Vendor") for eBook System Software, which includes computer software embedded in the electronic reader device ("eBook") and, as applicable, associated media, personal computer software intended for use in connection with the eBook, printed materials, and "online" or electronic documentation (collectively referred to as the "Software Application"). If you agreed to a Monthly Content Plan ("MCP"), such as the "Filament Books Book Club" subscription, at the time you purchased your eBook, you will be obligated to purchase a certain amount of books, magazines and newspapers each month during the term of your plan. This Agreement is also a legal contract between you and Vendor for your Monthly Content Plan.

BY USING, INSTALLING, OR OTHERWISE OPERATING THE SOFTWARE APPLICATION YOU AGREE TO BE BOUND BY THE TERMS OF THIS AGREEMENT, INCLUDING THE WARRANTY DISCLAIMERS, LIMITATIONS OF LIABILITY AND TERMINATION PROVISIONS BELOW, AND THE PROVISIONS RELATING TO THIRD PARTY PURCHASES. IF YOU DO NOT AGREE TO THE TERMS OF THIS AGREEMENT, DO NOT USE, INSTALL OR OTHERWISE OPERATE THE SOFTWARE APPLICATION. IF YOU HAVE BEGUN THE PROCESS OF INSTALLING THE SOFTWARE APPLICATION AND DO NOT AGREE TO THE TERMS OF THIS AGREEMENT, CANCEL AND EXIT NOW.

ANY RETURNS ARE SUBJECT TO THE RESPECTIVE RETAILER'S RETURN POLICY.

License Terms

Following acceptance of this Agreement, you may execute, install and use one (1) registered copy of the Software Application for your own personal, individual use.

Use on a reader device: You may use the single registered copy of the Software Application only with the eBook and electronic distribution system, authorized by Vendor.

Other Limitations

You may not rent, lease or lend the Software Application.

Vendor may provide you with support services related to the Software Application ("Support Services"). Use of Support Services is governed by Vendor policies and programs described in the User manuals, in "online" documentation, and/or in other Vendor-provided materials. Any supplemental software code provided to you as part of the Support Services shall be considered part of the Software Application and subject to the terms and conditions of this Agreement. With respect to technical information you provide to Vendor as part of the registration of your license to the Software Application or in connection with the Support Services, Vendor may use such information for its business purposes, including for product support and development.

You may permanently transfer all of your rights under this Agreement, provided that you retain no copies, you transfer all of the Software Application (including all component parts, the eBook device, the media and printed materials, any upgrades and your registration), and the recipient agrees to the terms of this Agreement.

You may not translate, reverse engineer, decompile, disassemble or otherwise create derivative works of the Software Application or attempt in any way to obtain the Software Application source code.

You may not modify the Software Application or any portion thereof, or merge all or any part of the Software Application with another program.

You may not alter, obscure or remove any labels or proprietary marks or notices on any portion of the eBook device or on any portion of the Software Application.

Without prejudice to any other rights, Vendor may terminate this Agreement if you fail to comply with the terms and conditions of this Agreement or if you violate Vendor's "Acceptable Use Policy" which Vendor posts at www.filamentbooks.com. In such event, you must destroy all copies of the Software Application and all of its component parts, and Vendor may suspend or deactivate your use of the Software Application with or without notice.

Monthly Content Plan

Some eBooks are made available to consumers for a reduced initial price if these consumers agree to spend a fixed monthly amount on content, such as books, magazines and newspapers for the eBook. These subscription plans (e.g. "Filament Books Book Club") are known as Monthly Content Plans ("MCP") and have certain terms and conditions that are described in this section.

If you agreed to a MCP at the time of purchase of your eBook, you must provide Vendor with a valid major credit card number. It is your responsibility to ensure that Vendor has a valid major credit card on file for you for the entire term of your subscription period. You agree that Vendor may charge your credit card for the initial payment that you agreed to at the time of purchase.

You also agree that Vendor may bill your credit card for the monthly content subscription fee that you agreed to at the time of purchase. Your second monthly subscription fee will be billed to your credit card one month after your initial payment and each subsequent monthly subscription payment will be billed to your credit card each month thereafter until the end of your contract term.

If you cancel your contract with Vendor prior to paying the total amount agreed upon or if your fail to maintain a valid major credit card on file with Vendor, you will be billed a \$250 penalty.

Limited Warranty and License Agreement

Miscellaneous

Purchases via Personal Computer: All purchases of goods through an online store are subject to the terms and conditions of the respective store accessed via the Internet. Under no circumstances shall Vendor be liable for any claim related to such a purchase.

Usage by Minors: Vendor cannot prohibit minors from using the eBook device and/or a catalog. Vendor must rely on parents, guardians and those responsible for supervising minors to decide which materials are appropriate for such minors to view and/or purchase. Vendor requires that all purchases be made by individuals 18 years of age or older.

Proprietary Rights

Copyright: All title and copyrights in and to the Software Application (including, without limitation, any images, photographs, animations, video, audio, music, text, and "applets" incorporated into the Software Application), the accompanying media and printed materials, and any copies of the Software Product are owned by Vendor or its suppliers. The Software Application is protected by copyright laws and international treaty provisions. Therefore, you must treat the Software Application like any other copyrighted material, subject to the provisions of this Agreement.

U.S. Government Restricted Rights: The Software Application and documentation are provided with RESTRICTED RIGHTS. Use, duplication, or disclosure by the Government is subject to restrictions as set forth in subparagraph (c)(1)(ii) of the Rights in Technical Data and Computer Software clause at DFARS 252.227-7013 or subparagraphs (c)(1) and (2) of the Commercial Computer Software - Restricted Rights at 48 CFR 52.227-19, as applicable. Manufacturer for such purpose is Vendor.

Submissions: Should you decide to transmit to Vendor's website or to any website supporting the electronic distribution authorized by Vendor by any means or by any media any materials or other information (including, without limitation, ideas, concepts or techniques for new or improved services and products), whether as information, feedback, data, questions, comments, suggestions or the like, you agree such submissions are unrestricted and shall be deemed non-confidential and you automatically grant Vendor and its assigns a non-exclusive, royalty-free, worldwide, perpetual, irrevocable license, with the right to sublicense, to use, copy, transmit, distribute, create derivative works of, display and perform the same. This agreement does not include Personal Content files submitted for upload to your online bookshelf.

Personal Content: Should you decide to use the Personal Content feature of Vendor's website and your Online Bookshelf, you may not upload Content protected by copyright, or other proprietary right, without obtaining permission of the owner of the copyright or other propriety right. The unauthorized submission or distribution of copyrighted or other proprietary Content is illegal and could subject the User to criminal prosecution as well as personal liability for damages in a civil suit. User will be liable for any damage resulting from any infringement of copyrights or proprietary rights, or from any other harm arising from such submission.

Disclaimer of Warranty

THIS SOFTWARE AND THE ACCOMPANYING FILES ARE PROVIDED "AS IS." VENDOR AND ITS SUPPLIERS DO NOT AND CANNOT WARRANT THE PERFORMANCE OR RESULTS YOU MAY OBTAIN BY USING THE SOFTWARE OR SUCH FILES. VENDOR AND ITS SUPPLIERS MAKE NO WARRANTIES, EXPRESS OR IMPLIED, AS TO TITLE OR INFRINGEMENT OF THIRD-PARTY RIGHTS, MERCHANTABILITY OR FITNESS FOR ANY PARTICULAR PURPOSE.

Good data processing procedure dictates that any program be thoroughly tested with non-critical data before relying on it. The User must assume the entire risk of using the Software Application.

ANY LIABILITY OF VENDOR FOR A DEFECTIVE COPY OF THE SOFTWARE APPLICATION WILL BE LIMITED EXCLUSIVELY TO REPLACEMENT OF YOUR COPY OF THE SOFTWARE APPLICATION WITH ANOTHER COPY OR REFUND OF ANY INITIAL LICENSE FEE VENDOR RECEIVED FROM YOU FOR THE DEFECTIVE COPY OF THE SOFTWARE APPLICATION. IN NO EVENT WILL VENDOR OR ITS SUPPLIERS BE LIABLE TO YOU FOR ANY CONSEQUENTIAL, INCIDENTAL OR SPECIAL DAMAGES, INCLUDING ANY LOST PROFITS OR LOST SAVINGS, EVEN IF A VENDOR REPRESENTATIVE HAS BEEN ADVISED OF THE POSSIBILITY OF SUCH DAMAGES, OR FOR ANY CLAIM BY ANY THIRD PARTY.

Some states or jurisdictions do not allow the exclusion or limitation of incidental, consequential or special damages, or the exclusion of implied warranties or limitations on how long a given warranty may last, so the above limitations may not apply to you.

Governing Law

This Agreement shall be governed by the laws of the State of California.

License Agreement & FCC Statement

FCC Statement

U.S. Federal Communication Commission (FCC) Statement

This device complies with part 15 of the FCC Rules. Operation is subject to the following two conditions: (1) This device may not cause harmful interference, and (2) this device must accept any interference received, including interference that may cause undesired operation.

This equipment generates, uses, and can radiate radio frequency energy and, if not installed and used in accordance with the instructions, may cause harmful interference to radio communications. It has been tested and found to comply with the limits for a Class B digital device pursuant to Part 15 of the FCC Rules. These limits are designed to provide reasonable protection against harmful interference in a residential installation. However, there is no guarantee that interference will not occur in a particular installation. If this equipment does cause harmful interference to radio or television reception, which can be determined by turning the equipment off and on, the user is encouraged to try to correct the interference by one or more of the following measures:

- Reorient or relocate the receiving antenna.
- Increase the separation between the eBook device and the receiver.
- Connect the eBook power adapter to an outlet on a circuit different from that to which the receiver is connected.
- Consult an experienced radio/TV technician for help.

Any unauthorized changes or modifications to the eBook device could void the user's authority to operate the equipment.

Note: This equipment complies with Part 68 of the FCC Rules. On the rear panel of this equipment is a label that contains, among other information, the FCC Registration Number and Ringer Equivalence Number (REN) for this equipment. You must, upon request, provide this information to your telephone company.

Connection to the telephone network should be made by using standard modular telephone jacks, type RJ11C. The RJ11C plugs and/or jacks must comply with FCC Part 68 rules.

If your telephone equipment causes harm to the telephone network, the Telephone Company may discontinue your service temporarily. If possible, they will notify you in advance. But if advance notice isn't practical, you will be notified as soon as possible. You will be informed of your right to file a complaint with the FCC.

Your telephone company may make changes in its facilities, equipment, operations or procedures that could affect the proper functioning of your equipment. If they do, you will be notified in advance to give you an opportunity to maintain uninterrupted telephone service.

This equipment may not be used on coin service provided by the telephone company.
Connection to party lines is subject to state tariff.

If you experience trouble with this telephone equipment, please contact Filament Books Customer Service at the address and phone number listed below. The telephone company may ask that you disconnect this equipment from the network until the problem has been corrected or until you are sure that the equipment is not malfunctioning.

Do not disassemble this equipment. It does not contain any user-serviceable parts.

Troubleshooting

If you have trouble getting started with your Filament Books eBook device, check these tips for a solution.

If anything is missing or damaged

If any parts or accessories are missing, or if the screen is damaged, call Customer Support at 1-888-95 EBOOK.

If nothing happens when you turn on your eBook device

· If the screen stays dark after you press the Power button once, the battery may need to be charged (please refer to the top of page 3 in this guide for instructions on charging the eBook device.). The eBook icon should appear on the screen when your eBook device is turned on. Tap the eBook icon at the top left of the screen. When the Menu appears, check the Battery icon to see if it indicates that the battery is charging.

· If you still see nothing on the screen, call Customer Support at 1-888-95 EBOOK.

If your eBook device appears to stop working

If something is visible on-screen but your eBook device doesn't respond, or if the screen goes dark and cannot be turned on again even with the power adapter, try the following procedure:

- Turn off your eBook device (if possible).
- Lift the rubber cover on the back of your eBook device.
- Insert the tip of a paper clip or similar-sized object into the "Reset" opening and press down for a few seconds.

This should allow your eBook device to turn on and function as usual.

If you think something is wrong with the battery or it does not recharge

See "Care of Your Battery" in the User's Guide on the eBookshelf on your eBook device for information on checking battery status and recharging the battery. If you need help diagnosing the battery's state, call Customer Support at 1-888-95 EBOOK.

If you have trouble with a connection

If you have trouble connecting to the eBook Network to register or download eBook Editions:

- Check to be sure the phoneline cord is securely connected at both ends, that you are using an analog line, and that the line is working.
- Check to be sure the dialing prefix and preferences are correct. Tap the eBook icon at the top left of the screen, tap "Settings" from the Menu and tap "Phone Connection."
 - Review "Connecting to the eBook Network" in the User's Guide on your eBookshelf for additional tips.
 - If you still have trouble with the connection, call Technical Support at 1-888-95 EBOOK.

Where to find more help

For more information on using your eBook device, including more troubleshooting information, see the User's Guide on the eBookshelf on your eBook device. Customer and Technical Support is available at 1-888-95 EBOOK.

eBook QUICK START GUIDE

Model: Filament Books eBook

Copyright © 2004 by eBook Technologies, Inc. All Rights Reserved.

Contents of this publication are not to be reproduced in any form by any means without written permission from eBook Technologies, Inc.

eBook Technologies, Inc.
7745 Herschel Avenue
La Jolla, CA 92037